

Time Attendance User's Manual

V1.0.1

Table of Contents

Table of Contents	1
1 Product Overview.....	5
1.1 Introduction	5
2 Installation Guide	6
2.1 Checklist	6
2.2 Panel and Interface	6
2.3 Appearance Dimensions	8
2.4 Installation Wiring.....	9
3 System Operation.....	9
3.1 Attendance.....	10
3.2 Main Menu.....	11
3.3 User	12
3.3.1 New User	12
3.3.2 Search and Edit User.....	14
3.3.3 New Department	15
3.3.4 Edit and Delete Department.....	16
3.4 Shift.....	18
3.4.1 Set Shift.....	18
3.4.2 Department Shift	25
3.4.3 Check	26
3.5 Data.....	27
3.5.1 Query Record.....	27
3.5.2 Export 1 Month Logs.....	28
3.5.3 Export 1 Month Exception.....	28
3.6 Features	29
3.6.1 Add User in Batch	29
3.6.2 State Switch	30

3.6.3	Bell	31
3.7	System Config.....	33
3.7.1	Set Time and Date	34
3.7.2	Volume.....	35
3.7.3	Restore.....	36
3.7.4	Relay Mode.....	36
3.7.5	Restart Device.....	37
3.8	Communication.....	37
3.9	USB.....	38
3.9.1	Export User Info.....	39
3.9.2	Firmware Update.....	39
3.10	System Info	39
4	Daily Operation	40
5	FAQ.....	41
	Appendix a Fingerprint Operation.....	42
	Appendix 2 Text Input	44

Important Safeguards and Warnings

Please read the following safeguards and warnings carefully before using the product in order to avoid damages losses and body injuries. After reading, please well keep this user's manual.

Note:

- Do not install the device at position exposed to sunlight or in high temperature. Temperature rise in device may cause fire.
- Do not expose the device to lampblack, steam or dust. Otherwise it may cause fire or electric shock.
- The device must be installed on solid and flat surface in order to guarantee safety under load and earthquake. Otherwise, it may cause device to fall off or turnover.
- Do not drop or splash liquids onto the device, and do not place container with full liquid on the device to prevent liquid spilling from entering the device.
- Do not block air vent of the device or ventilation around the device. Otherwise, temperature in device will rise and may cause fire.
- Use the device only within rated input and output range.
- Do not disassemble the device without professional instruction.
- Please transport, use and store the product under appropriate temperature and humidity.

Warning:

- Please use button cell properly to avoid fire, explosion and other dangers.
- Please replace used battery with battery of the same type.
- Do not use power line other than the one specified. Please use it properly within rated range. Otherwise, it may cause fire or electric shock.
- Please use power supply matching SELV requirements, and IEC60950-1 Limited Power Source. Power supply shall follow requirements on device label.
- For I-type structure product, connect it to power supply plug with GND protection.
- If you use power plug or appliance coupler as disconnecting device, please maintain the disconnecting device available to be operated all the time.

Privacy Protection Notice

As the device user or data controller, you might collect personal data of others' such as face, fingerprints, car plate number, Email address, phone number, GPS and so on. You need to be in compliance with the local privacy protection laws and regulations to protect the legitimate rights and interests of other people by implementing measures include but not limited to: providing clear and visible identification to inform data subject the existence of surveillance area and providing related contact.

About the Manual

- The Manual is for reference only. If there is inconsistency between the Manual and the actual product, the actual product shall prevail.
- We are not liable for any loss caused by the operations that do not comply with the Manual.
- The Manual would be updated according to the latest laws and regulations of related regions. For detailed information, see the paper User's Manual, CD-ROM, QR code or our official website. If there is inconsistency between paper User's Manual and the electronic version, the electronic version shall prevail.
- All the designs and software are subject to change without prior written notice. The product updates might cause some differences between the actual product and the Manual. Please contact the customer service for the latest program and supplementary documentation.
- There still might be deviation in technical data, functions and operations description, or errors in print. If there is any doubt or dispute, please refer to our final explanation.
- Upgrade the reader software or try other mainstream reader software if the Guide (in PDF format) cannot be opened.
- All trademarks, registered trademarks and the company names in the Manual are the properties of their respective owners.
- Please visit our website, contact the supplier or customer service if there is any problem occurred when using the device.
- If there is any uncertainty or controversy, please refer to our final explanation.

1 Product Overview

1.1 Introduction

All-in-one time attendance is an attendance device integrating card, fingerprint, config and execution. It is suitable for office, commercial building, school and etc.

Time attendance functions:

- Touch button+LCD display, TCP-IP protocol
- Fixed and flexible attendance mode.
- Card, fingerprint or password
- 3000 fingerprints and 1000 users.
- 150,000 card records
- Simple Access control or External bell
- 64 groups of holiday setup.

Warning:

This product needs external power, please use DC 12V 0.5A adaptor as power, and work temperature shall be within $-5^{\circ}\text{C}\sim 55^{\circ}\text{C}$.

2 Installation Guide

2.1 Checklist

No.	Name	Quantity	Note
1	Unit	1	-
2	Installation bracket	1	-
3	Installation map	1	-
4	M4×30 cross pan head flat screw	2	Used to fix bracket for concealed mount
5	M3×6 inner hex sunk head screw	1	Used to fix device from bottom to installation bracket
6	T10 inner hex wrench	1	-
7	Screws	1 pack <ul style="list-style-type: none"> • ST3×18 self-tapping screw, 4 • Expansion bolt, 4 	When there is direct mount, used to fix installation on surface.
8	Quick start guide	1	-

Chart 2-1

2.2 Panel and Interface

Time attendance is in Figure 2-2 and Figure 2-3.

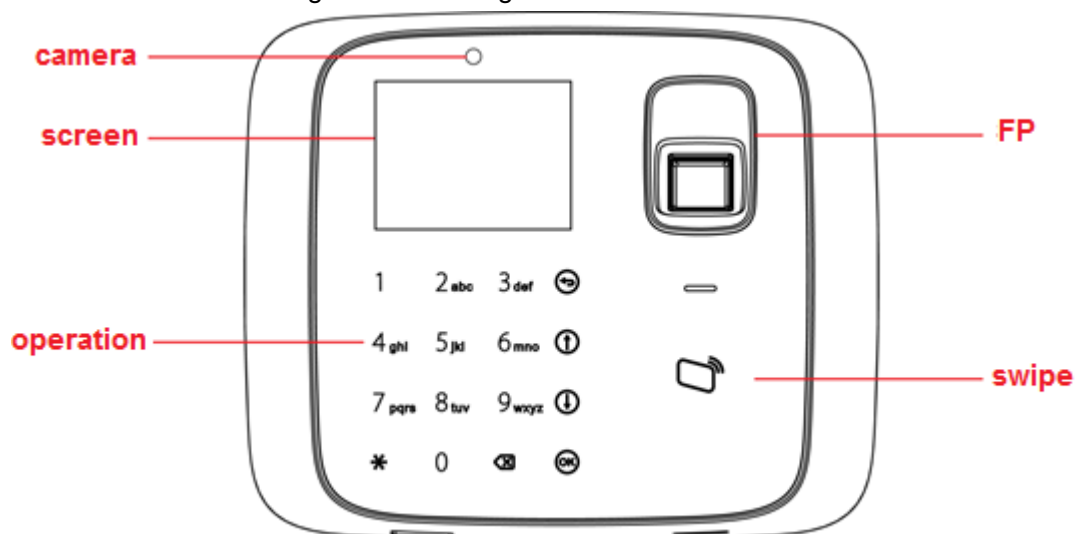

Figure 2-1







Icon	Note
0~9	Number key, for number and letter input
	Return or exit
	Up
	Down
	Enter or confirm
	Switch, between function or input
	Delete

Chart 2-2

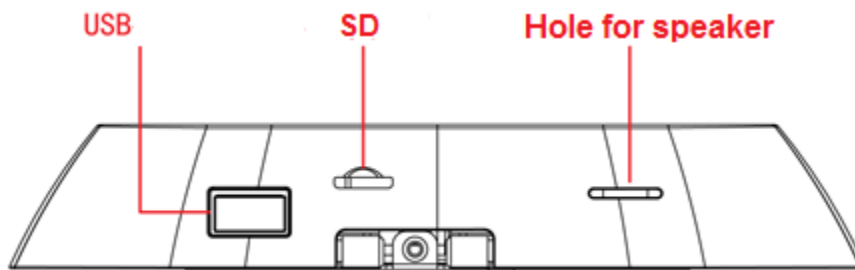

Figure 2-2

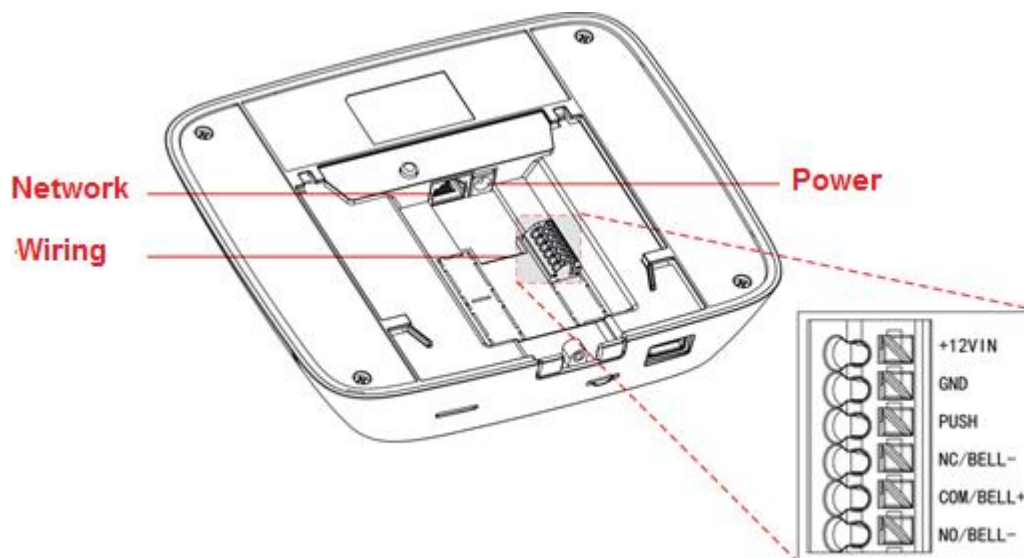

Figure 2-3

Port	Note
+12VIN	DC 12V power

Port	Note
GND	GND
PUSH	Unlock
NC/BELL-	Lock NC or BELL (disconnect triggered)
COM/BELL+	Lock COM or BELL+
NO/BELL-	Lock NO or BELL- (close triggered)

Chart 2-3

2.3 Appearance Dimensions

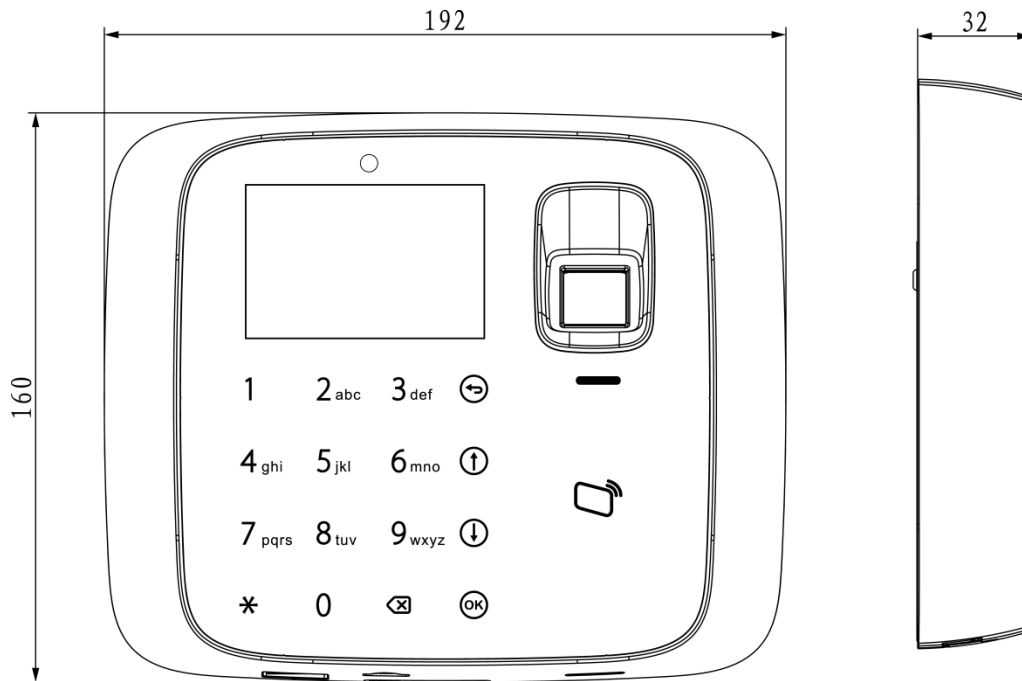

Figure 2-4

2.4 Installation Wiring

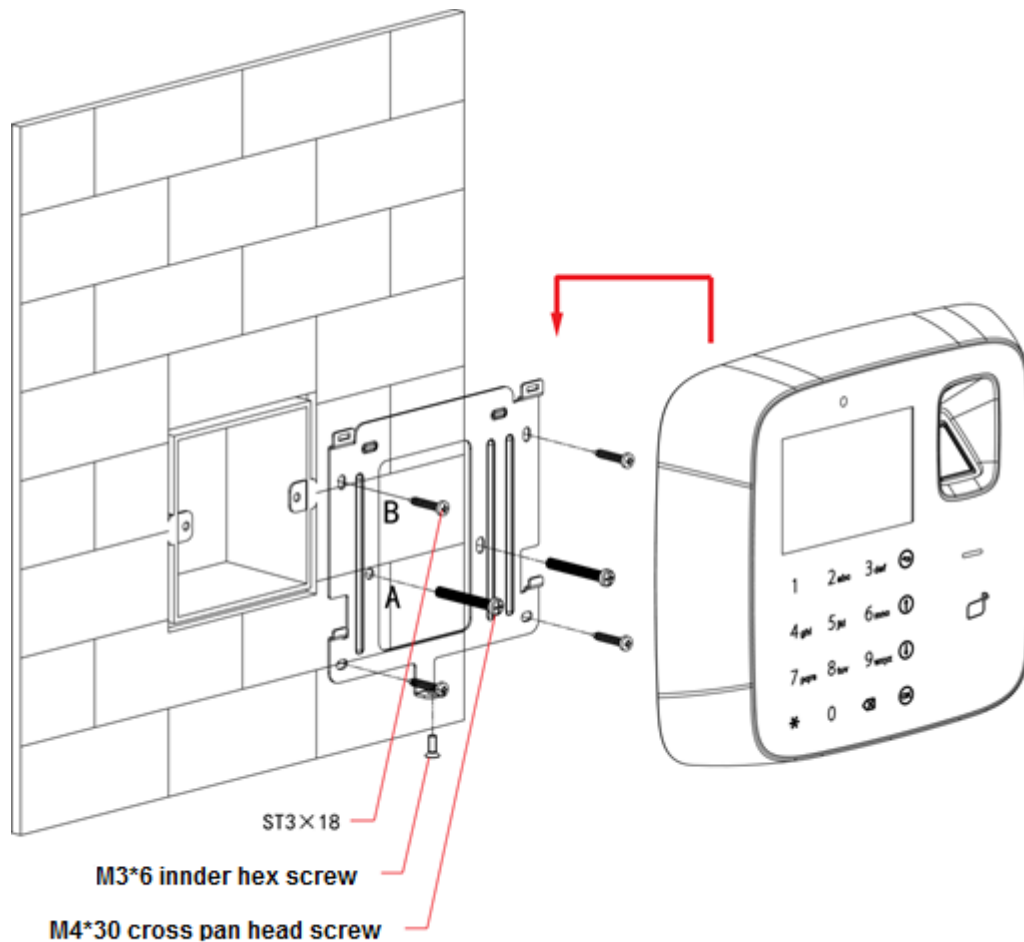

Figure 2-5

Installation step:

Step 1. Paste installation map on installation surface, and open hole according to the map. Insert expansion bolt into the hole.

Step 2. Install bracket.

- If there is concealed mount, fix bracket on concealed mount with screw A.
- If there is no direct mount or cannot be well fixed, fix bracket on wall with screw B. You must embed expansion bolt in wall first.

Step 3. According to direction on map, hang the device on bracket.

Step 4. From device bottom, insert and fasten screw, lock the device.

3 System Operation

Note:

- Fingerprint record is in Appendix 1.
- Input of text is in Appendix 2.

3.1 Attendance

Warning:

During attendance, please DO NOT change system config, system time or power off the device, since these will cause abnormal attendance.

Plug the device to power, device boots up and shows time info, see Figure 3-1.

Note:

If you did not operate over 45s in one page, it will return to standby page.

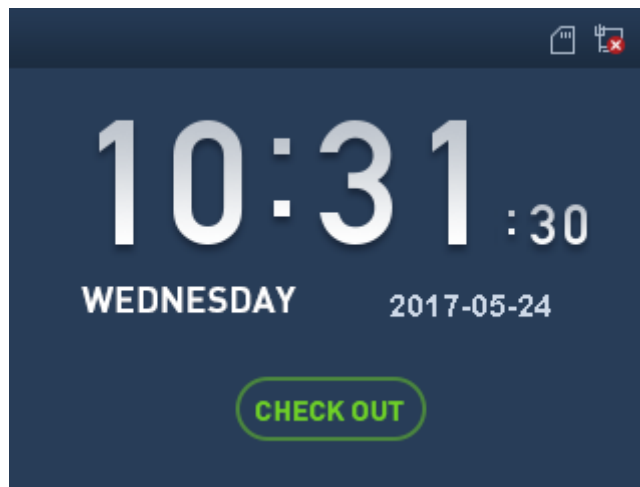

Figure 3-1

- Click number key, see Figure 3-2. Enter user ID and password can pass attendance.

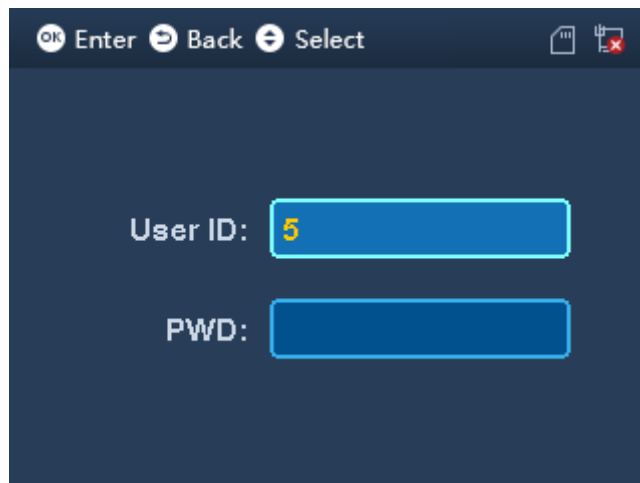



Figure 3-2

- In fingerprint area, press your finger to pass attendance.
- In card swiping area, swipe card and pass attendance.
- Click * to switch attendance status. Connect to platform and sync status to platform, used on platform.

- After you pass personal attendance, click , to show personal attendance record, see Figure 3-3 and Figure 3-4.

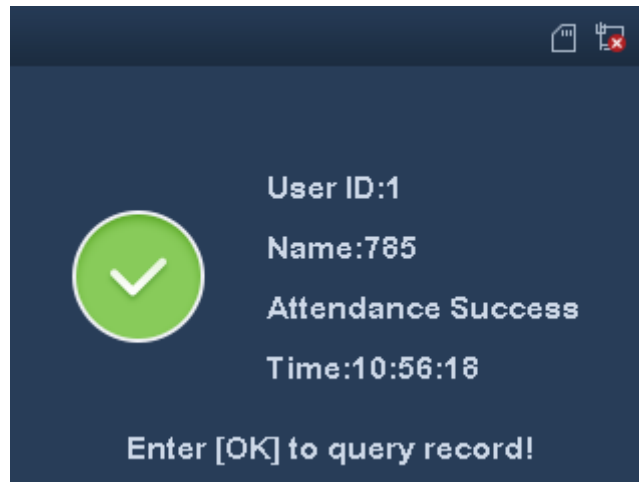

Figure 3-3

Time	User ID	Name
05-24 10:52	1	785
05-24 10:49	1	785

Figure 3-4

Note:

- Add password, fingerprint and card, refer to Ch 3.3.1.
- Details of attendance refer to Ch 3.6.2.

3.2 Main Menu







Click , system shows main menu, see Figure 3-5.

Note:

If you have added admin user in User Level (User→User Level), you can login via fingerprint, card or password.



Figure 3-5

- Click  or  to select, click  or directly enter number below each function.
- When you insert USB disk, you can see  at the upper right corner.
- When you insert SD card, you can see  at the upper right corner.
- When you connect the device to network, you can see  at the upper right corner.

If disconnected, you can see .

3.3 User

3.3.1 New User

You can create user, and set new user info which includes ID, username, fingerprint, card, password, photo and etc. A user can pass attendance via fingerprint, card or password. System supports up to 1000 users.

Step 1. Select User>New User, click OK. See Figure 3-6 and Figure 3-7.

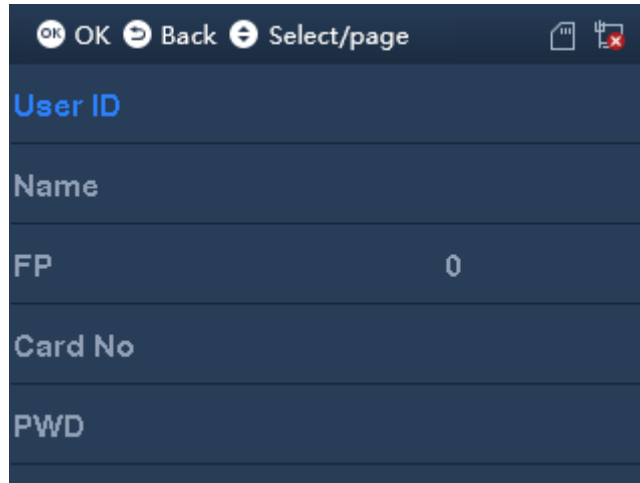

Figure 3-6

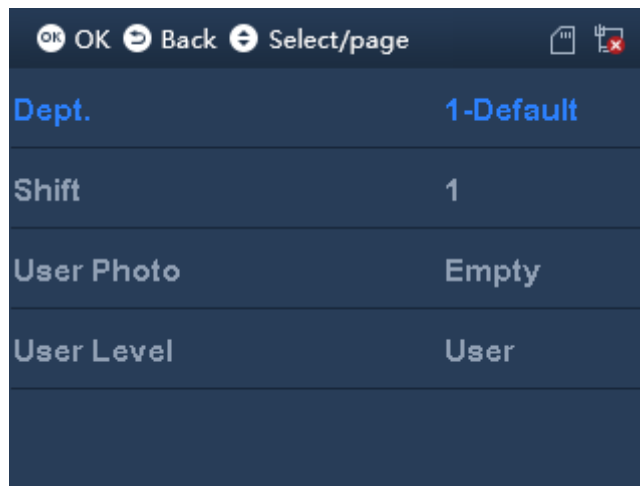







Figure 3-7

Step 2. Click  or  to select parameter, click  to confirm. Enter number into, and click  to save.

Note:

User ID, card, password, department and shift can be edited via number key or backspace.

Parameter	Note
User ID	Enter user no., max 11 digits of number.
Name	Enter username, max 32 letters. Click  to switch input method.
FP	Record fingerprint. One user can record up to 3 fingerprints, and each fingerprint requires confirmation of three times. Follow audio prompts to add.
Card No.	Enter card no., or swipe card.
Password	Enter password, which can be 1-8 digits of number.
Department	Click  to select preset department. Refer to chapter 3.3.3.



Parameter	Note
Shift	Enter preset shift. <ul style="list-style-type: none"> • If you do not enter shift, then attendance depends on shift linked to department. • If input shift do not match department linked shift, subject to input shift. Refer to Ch 3.4.1.
User Photo	Click  to take photo, saved on SD card as user photo.
User Level	Click  to switch level. <ul style="list-style-type: none"> • User, only attendance right. • Admin, can login system to config.

Chart 3-1

Step 3. When you finish config, click .

Step 4. Click  to save.

3.3.2 Search and Edit User

You can search user in the system, to modify and delete user info.

Select User>Edit or Delete User, click . See Figure 3-8.

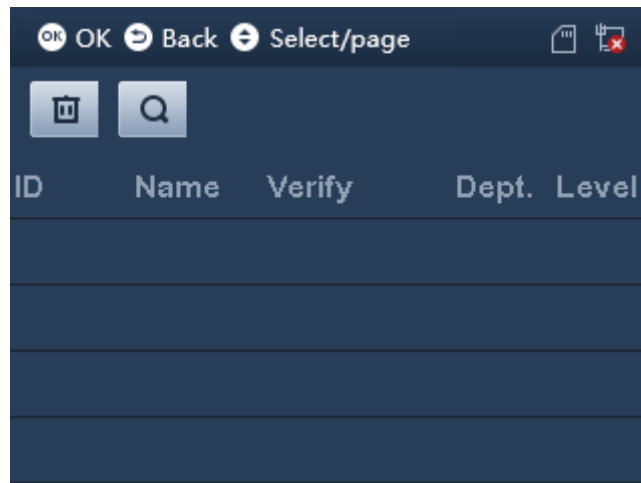







Figure 3-8

- , card method for attendance.
- , password method for attendance.
- , fingerprint method for attendance.
- Level. 0 is normal user and 1 is admin.

Edit and Delete Single User

Click  or  to select user, click , see Figure 3-9.

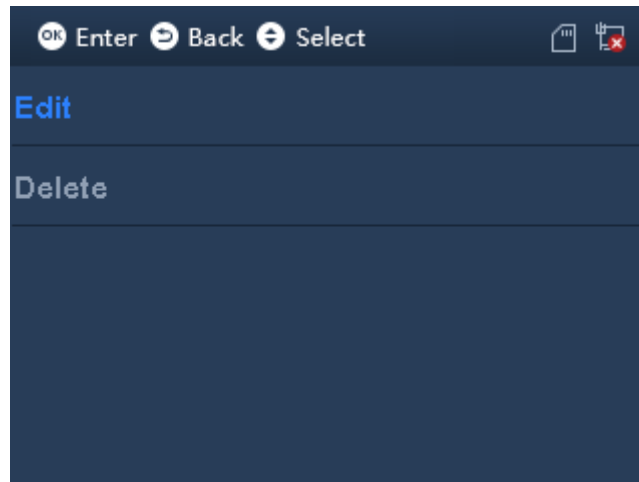



Figure 3-9

- Select Edit, click , to edit user.
- Select Delete, click , to delete user.

Delete and Search All Users

Click  to switch to delete and search button above, see Figure 3-10.

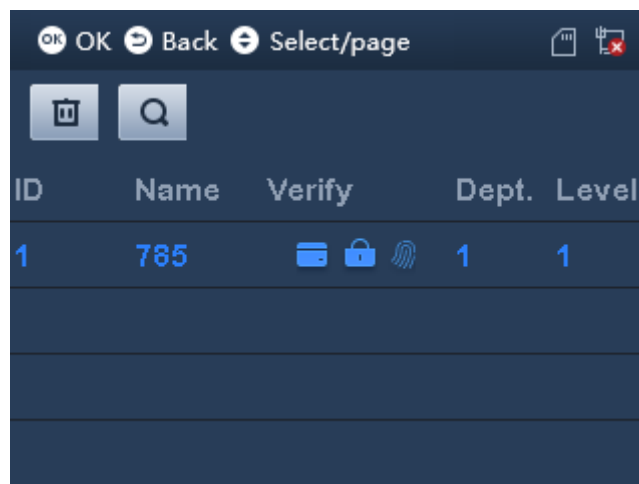





Figure 3-10

- Select , click , to delete all users.
- Select  to search user by no.

3.3.3 New Department

You can create department, and set user group. Different departments can have different

shifts. Max department is 30.

Step 1. Select User>New Department, click . See Figure 3-11.

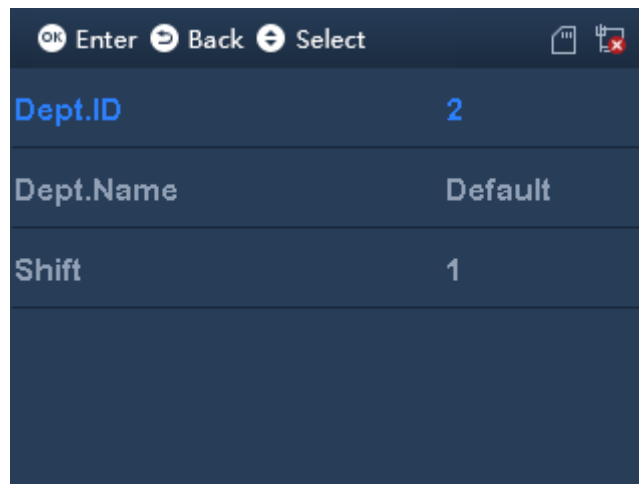





Figure 3-11

Step 2. Click  or  to select parameter, click . Click number key to enter info, and click  again to save.



Parameter	Note
Department ID	System uses number by default.
Department Name	Customize department name, up to 32 characters. Click  to switch input method.
Shift	Enter preset shift, then it applies to add users of the department. Attendance follows this shift. Refer to chapter 3.4.1.

Chart 3-2

Step 3. When you finish, click .

Step 4. Click  to save.

3.3.4 Edit and Delete Department

You can search department in the system, to edit and delete department.

Select User>Edit and Delete Department, click . See Figure 3-12.

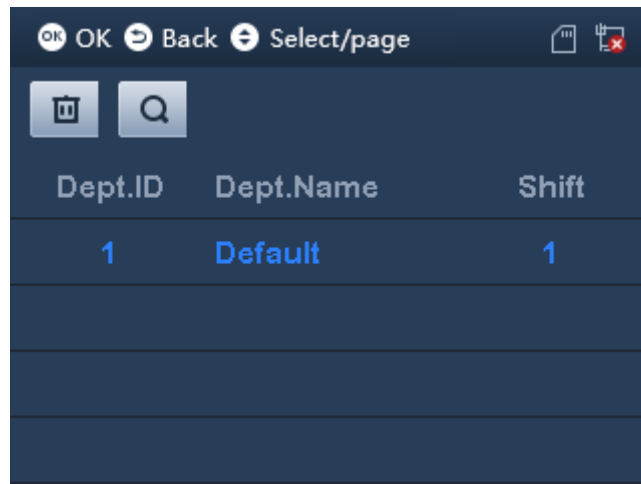

Figure 3-12

Edit and Delete Single Department

Click  or  to select department, click , see Figure 3-13.

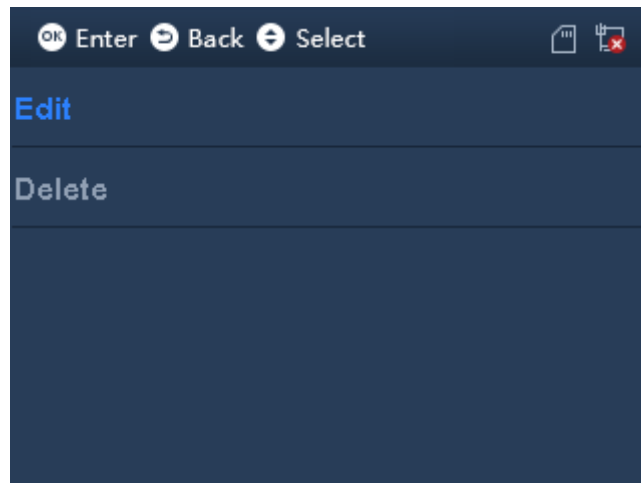



Figure 3-13

- Select Edit, click , to edit department.
- Select Delete, click , to delete department.

Delete and Search unused departments.

Click  to switch to delete and search button above, see Figure 3-14.

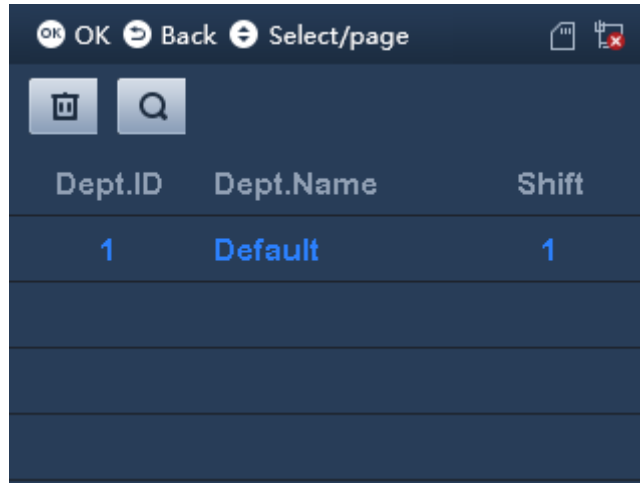





Figure 3-14

- Select , click  to delete all departments.
- Select  to search department by no.

3.4 Shift

3.4.1 Set Shift

You can add shift, and set attendance time and type, up to 20 shifts.

3.4.1.1 Add Shift

Step 1. Select Shift>Shift Setup>Shift, click , see Figure 3-15.

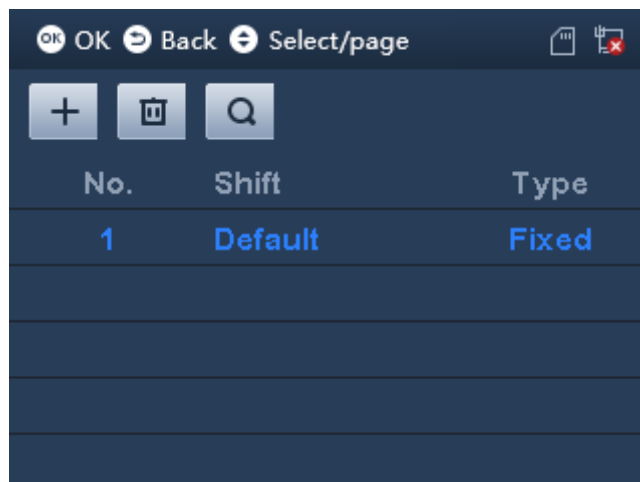

Figure 3-15

Step 2. Click ✖, to switch to function key above, select + and click OK.

Step 3. Click ↑ or ↓ to select parameter, click OK to confirm. Enter number and click OK to save.

Parameter	Note
No.	System auto generated.
Shift Name	Customize shift name, max 32 characters. Click ✖ to switch input method.
Shift Type	Select attendance type, including fixed and flexible. <ul style="list-style-type: none"> Fixed, set valid attendance period. Invalid when out of this period. Flexible, no limit on work time, follow two rules: 1) hours at work per day, 2) start time of word each weekday.
Cycle Type	Set work and rest time, attendance for weekday only. Include cycle by week and month. <ul style="list-style-type: none"> Cycle by week, such as which days in a week are weekdays. Cycle by month, set by date.

Chart 3-3

Step 4. When you finish, click ↩.

Step 5. Click OK to save.

Shift Type

Select shift type, click OK, see Figure 3-16.

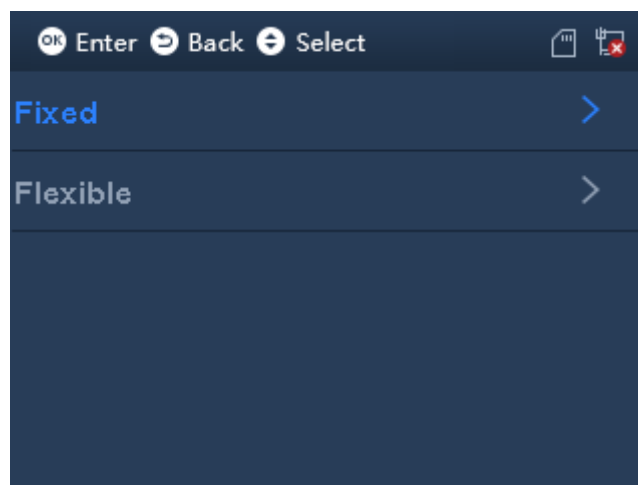

Figure 3-16

Fixed Attendance

Step 1. Select Fixed, click OK. See Figure 3-17.

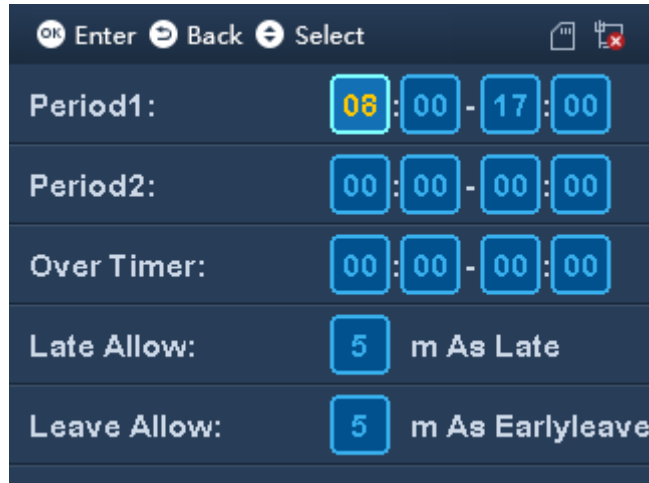



Figure 3-17

Step 2. Click  or  to select parameter, click  to confirm.

Parameter	Note
Period 1 and 2	Set attendance period, as sign in/out period. When sign in/out is within set period, attendance is abnormal, otherwise attendance is normal. System supports two periods. If you set two periods, period 1 and 2 must both have sign in within the period to be normal attendance.
Overtime	Set overtime period, as time period between sign in/out meet setup to be overtime work. Note: For valid overtime sign in, a user must sign in within set work off time of period 1 and 2.
Late Allow	Sign in time is later than designated work start time range. Unit is minute.
Leave Allow	Sign out time is earlier than designated work end time range.

Chart 3-4

Note:

Please set all attendance time precise to minute, such as 8:05.

Step 3. Click  to save.

Flexible Attendance

Step 1. Select Flexible, click . See Figure 3-18.

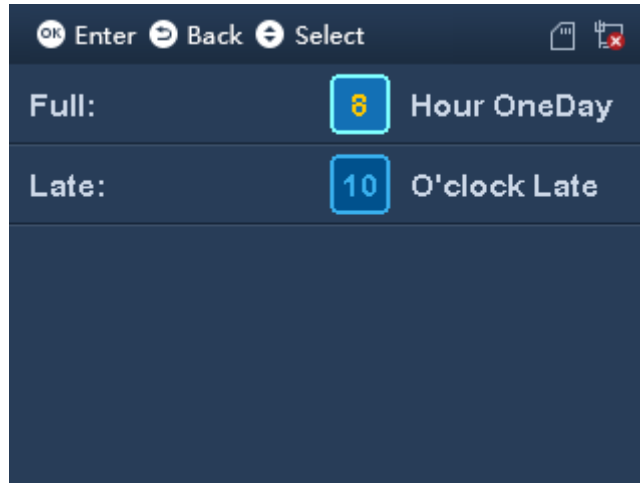



Figure 3-18

Step 2. Click  or  to select parameter, click . Click number key to enter.

Parameter	Note
Full	Set required work hour per weekday.
Late	Set sign in time. So sign in after this time will be record as late. Unit is hour.

Chart 3-5

Step 3. Click  to save. Click Return to add shift interface.

Cycle Type

Select Cycle Type, click , see Figure 3-19

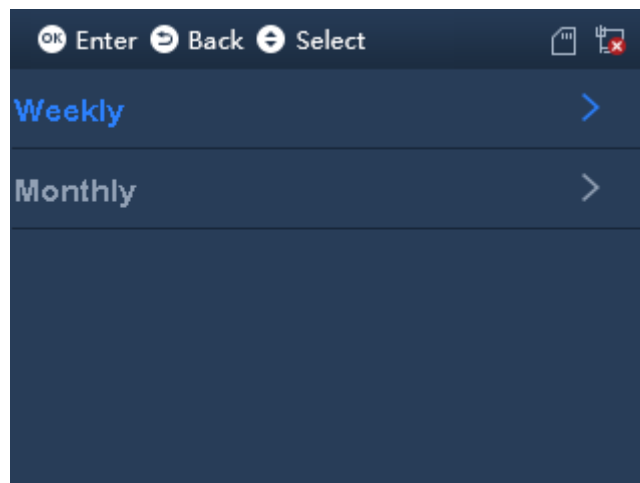



Figure 3-19

Weekly

Step 1. Select Weekly, click . See Figure 3-20.

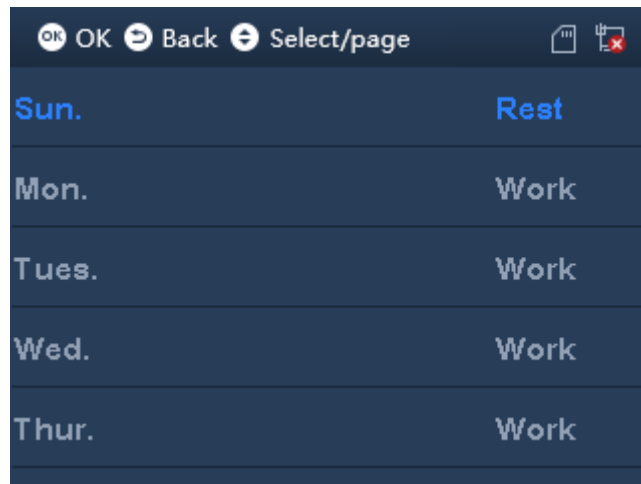

Figure 3-20

Step 2. Select week, click **OK** and select rest or work.

Step 3. Click **Back** to save.

Monthly

Step 1. Select monthly, click **OK**. See Figure 3-21.



Figure 3-21

Step 2. Select date, click **OK** and select rest or work.

Step 3. Click **Back** to save.

3.4.1.2 Edit and Delete Shift

You can search shift, modify and delete shift.

Edit and Delete Single Shift

Select Shift setup>Shift, select shift, click  . See Figure 3-22.

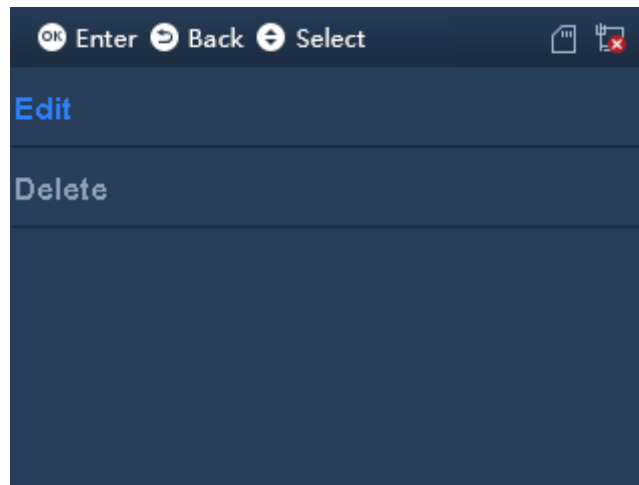





Figure 3-22

- Select Edit, click  to edit shift.
- Select Delete, click  to delete shift.

Delete and Edit All Shifts

Click , switch to delete and search buttons above, see Figure 3-23.

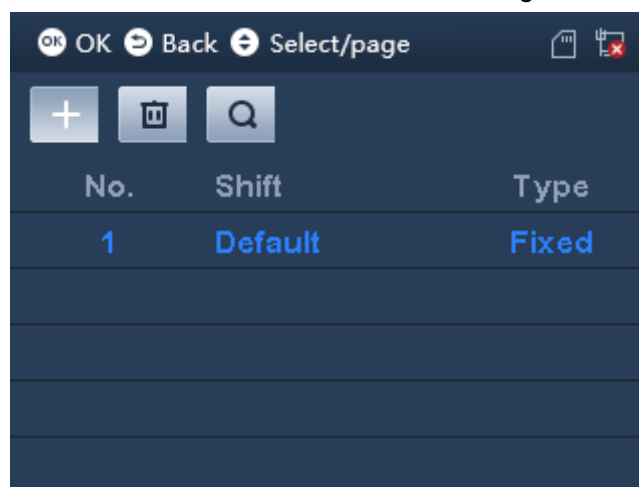





Figure 3-23

- Select , click  to delete all shifts.
- Select , to search shift by no.

3.4.1.3 Add Holiday

You can set holiday period up to 64 periods. All shifts within holiday period will have no attendance.

Step 1. Select Shift>Shift Setup>Holiday, click  .
See Figure 3-24.

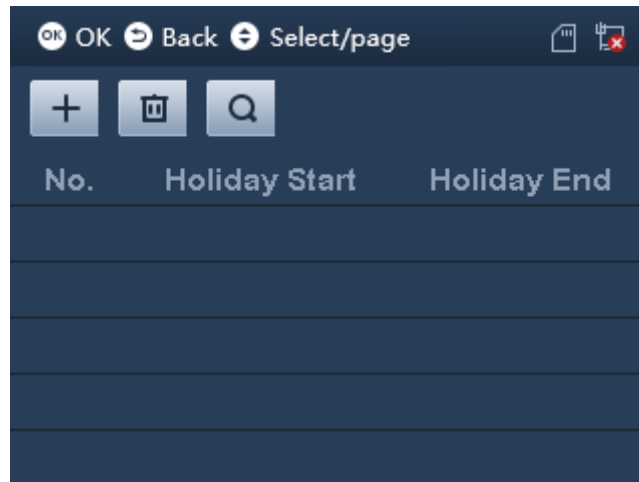





Figure 3-24

Step 2. Click , switch to function key above, click  and click  . See Figure 3-25.

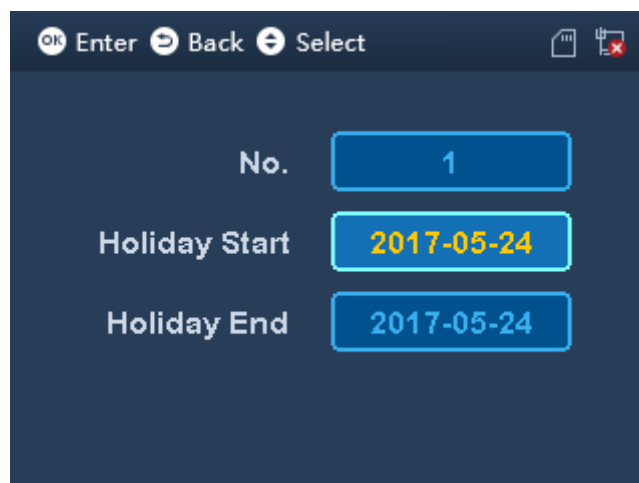



Figure 3-25

Step 3. Enter start date and end date, click  to save.

3.4.1.4 Edit and Delete Holiday

You can search holiday in system to modify and delete holiday.
Edit and Delete Single Shift

Select Shift setup>Holiday, select shift, click  . See Figure 3-26.

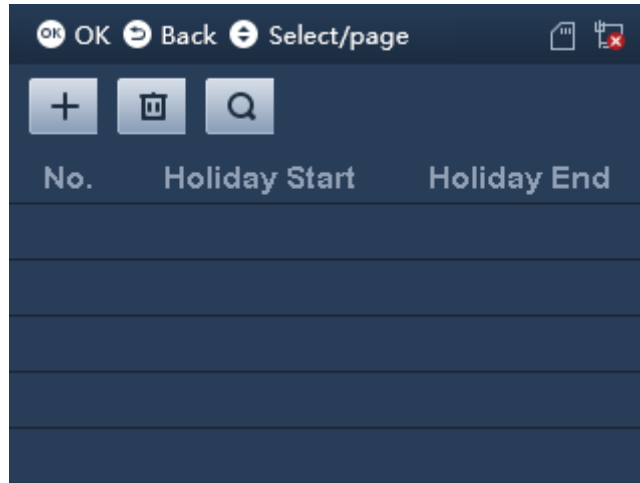

Figure 3-26

- Select Edit, click **OK** to edit holiday.
- Select Delete, click **OK** to delete holiday.

Delete and Edit All Holidays

Click *****, switch to delete and search buttons above, see Figure 3-23.

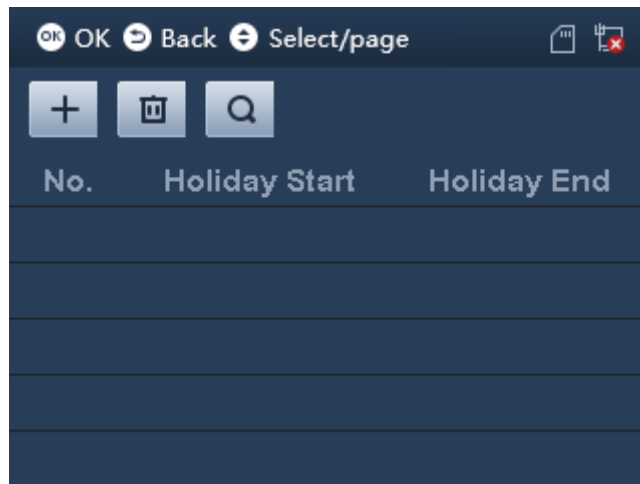



Figure 3-27

- Select , click **OK** to delete all holidays.
- Select , to search holiday by no.

3.4.2 Department Shift

You can set different shifts for different departments. Each department can select shift accordingly.

Step 1. Select Shift>Department Shift, click **OK**. See Figure 3-28.

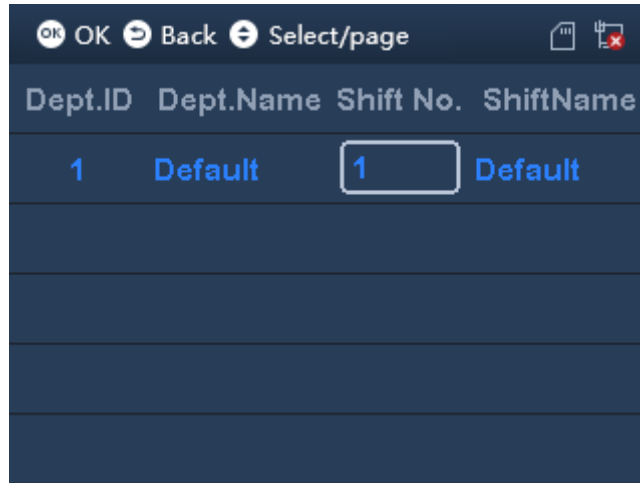



Figure 3-28

Step 2. Click  or  to select department ID.

Step 3. Click number key to input shift no, click  to save.

3.4.3 Check

You can set recheck time, as when you continuously swipe card within set time, it only records the first time of card swiping.

Step 1. Select Shift>Verification, click . See Figure 3-29.

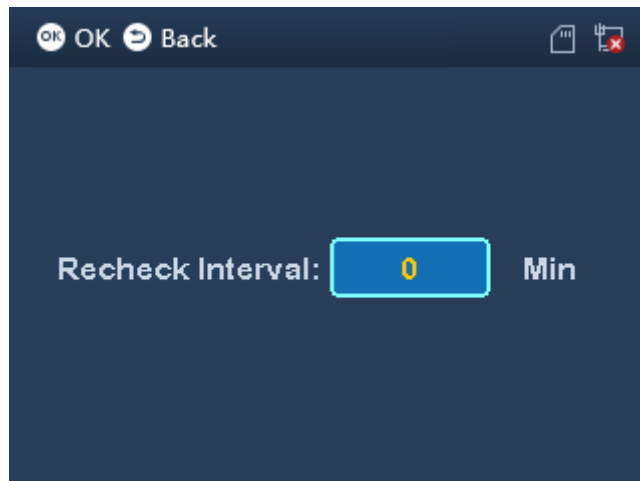



Figure 3-29

Step 2. Enter recheck time, and when you continuously swipe card within set time, it only recors the first time of card swiping.



Step 3. Click .

3.5 Data

Warning:

Make sure you have inserted USB disk into the device before you export attendance record. Do not eject USB disk or interrupt the operation during exporting, otherwise, the operation will fail.

You can search and export attendance and card record. System stores up to 150,000 card records.

Enter main menu, click  or  to select Data, click . Or click number key 3 directly. See Figure 3-30.

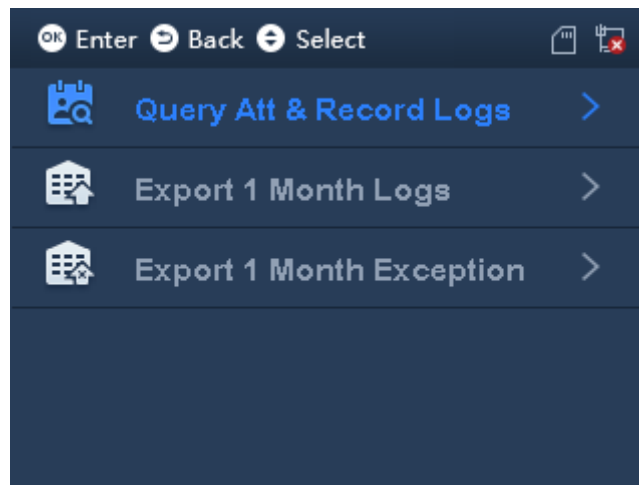

Figure 3-30

3.5.1 Query Record

Step 1. Select Data>Query Att&Record Logs. See Figure 3-31.

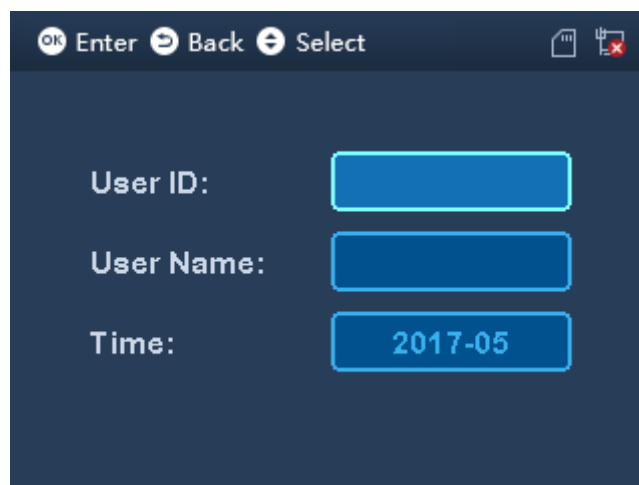

Figure 3-31

Step 2. Enter user ID and time.

- Enter user ID to get corresponding user name.
- Click **OK** to switch to time. YOU can search record of current month and previous month. After you set, move cursor to user ID or user name.

Step 3. Click **OK** to query.

Note:

- White means holiday or set holiday. Date before device exists is also white.
- Blue means normal attendance.
- Red means abnormal attendance, including late, leave and absent.
- Click **OK** again, export attendance record if queried month by use to generate excel file saved on USB disk.

3.5.2 Export 1 Month Logs

You can export all attendance records of current month or previous month to USB.

Step 1. Select Data>Export 1 Month Logs, click **OK**. See Figure 3-32.

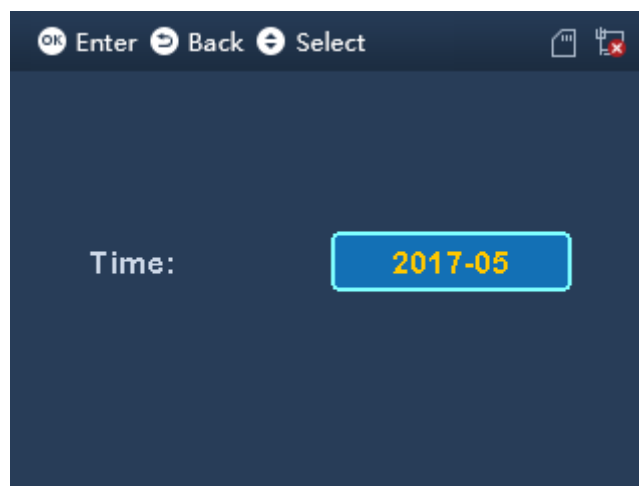

Figure 3-32

Step 2. Click **↑** or **↓** to select time, click **OK**. Excel file generated will be saved in USB.

3.5.3 Export 1 Month Exception

You can export all abnormal attendance records of current month or previous month to USB.

Step 3. Select Data>Export 1 Month Exception, click **OK**. See Figure 3-32.

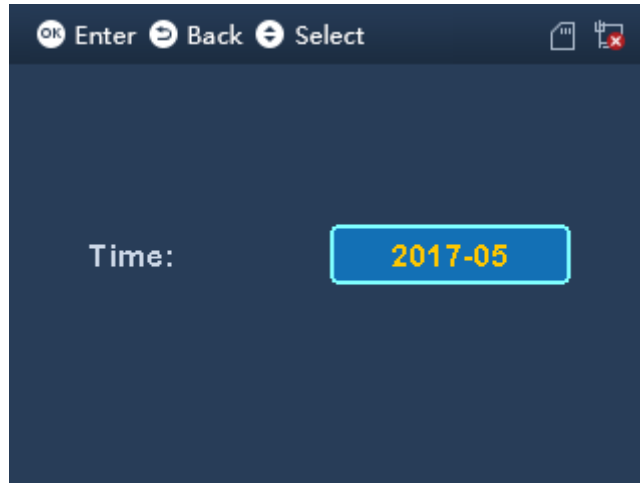







Figure 3-33

Step 4. Click  or  to select time, click . Excel file generated will be saved in USB.

3.6 Features

Enter main menu, click  or  to select Features, click . Or directly click 6. See Figure 3-34.

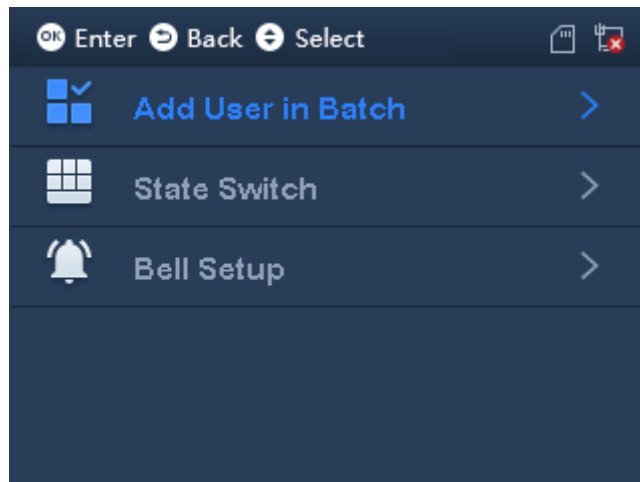



Figure 3-34

3.6.1 Add User in Batch

Enter start no., you can batch add user by swiping card.

Step 1. Select Features>Add User in Batch, click . See Figure 3-35.

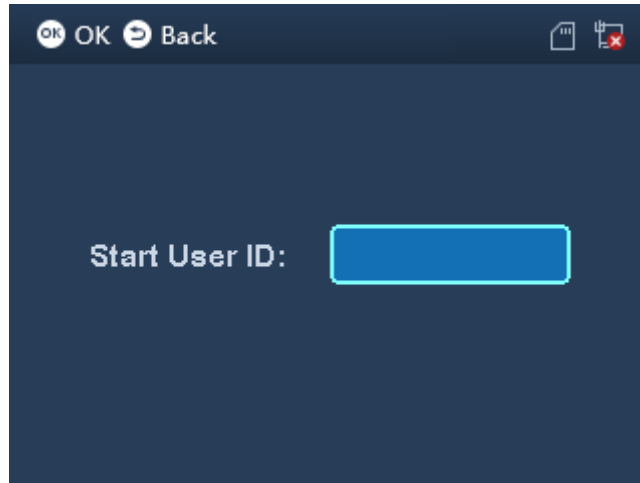



Figure 3-35

Step 2. Enter Start User ID, click . See Figure 3-36.

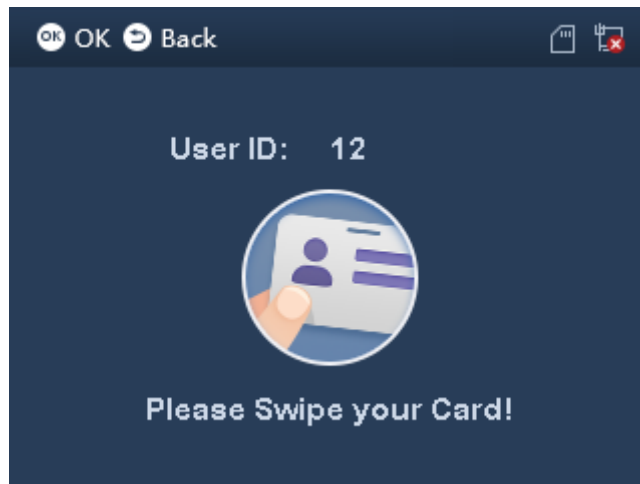

Figure 3-36

Step 3. In card swiping area, swipe card. No. will increase automatically as you swipe more card (auto bound to card no.).

When you finish, you can view and edit in User>Edit&Delete User.

3.6.2 State Switch

You can set attendance state and time according to actual condition. Set state is mainly applied to platform.

Step 1. Select Features>State Switch, click . See Figure 3-37.

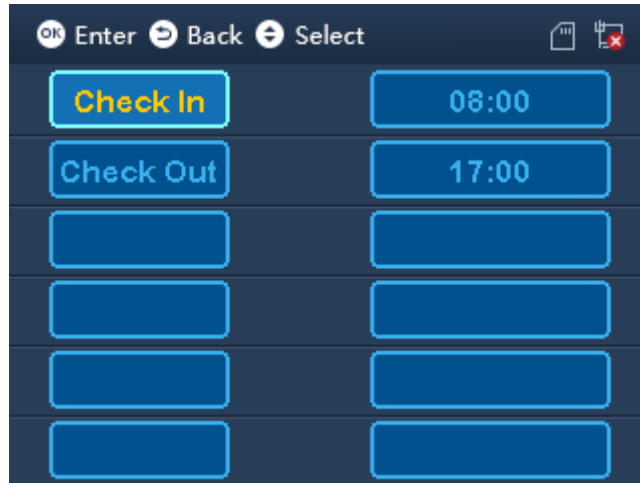





Figure 3-37

Step 2. Click  or , click  to switch status. Click number key to enter time.

Parameter	Note
Check in, check out	Set time of check in and out.
Break out and Break In	If you register to go out, please set time accordingly.
OT-In, OT-Out	If you register to work overtime, please set time accordingly.

Chart 3-6

Step 3. Click  to save.

In standby interface, it shows corresponding time status.

3.6.3 Bell

Bell mainly connects external bell, as a bell. When device is in relay mode, set bell and you can set bell ring time, when this time is reached, external bell will ring. See chapter 3.7.4.

3.6.3.1 New Bell

The system supports up to 8 bells.

Step 1. Select Features>Bell setup>New Bell, click . See Figure 3-38.

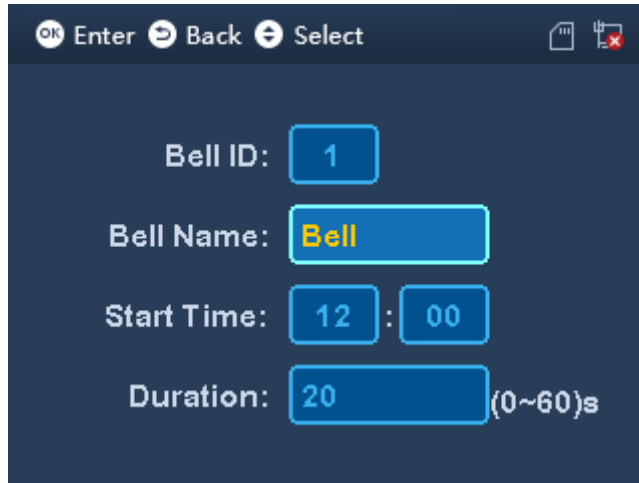

Figure 3-38

Step 2. Click or to select parameter, click .

Parameter	Note
Bell ID	System auto generated ID.
Bell Name	Customize bell name, max 32 characters.
Start Time	Start time of bell.
Duration	Duration of bell.

Chart 3-7

Step 3. Click to save, click to confirm.

3.6.3.2 Edit and Delete Bell

You can search bell in system and modify and delete bell.

Select Features>Bell setup>Search&Delete Bell, click . See Figure 3-39.

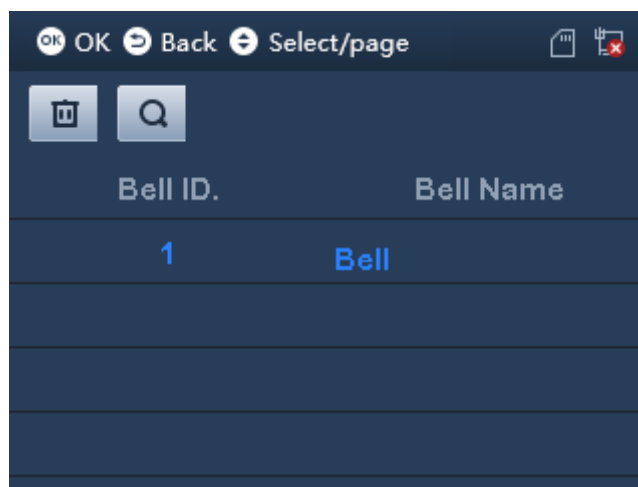

Figure 3-39

Edit and Delete Single Bell

Select bell, click . See Figure 3-40.

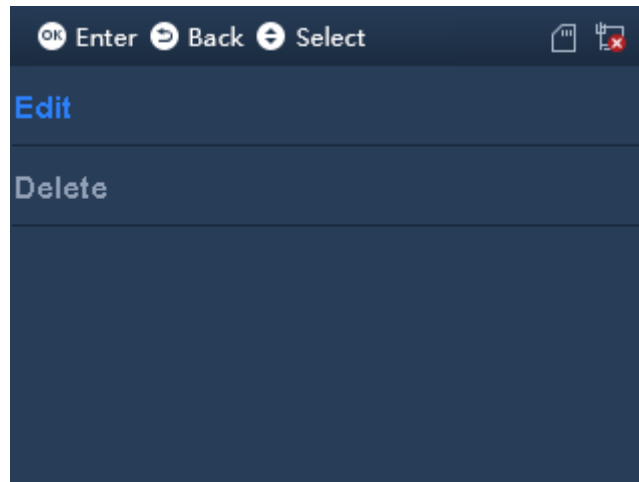





Figure 3-40

- Select Edit, click  to edit bell info.
- Select Delete, click  to delete bell info.

Delete All Bells

Click , switch to delete and search above, see Figure 3-41.

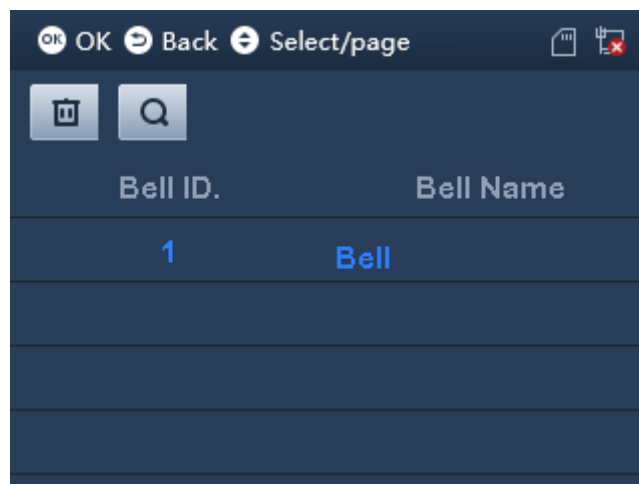







Figure 3-41

- Select , click  to delete all bells.
- Select  to search bell by ID.

3.7 System Config

You can set system time, volume, restore, relay mode and restart device.

Enter main menu, click  or  to delete SysConfig, click . Or directly click number key 7. See Figure 3-42.

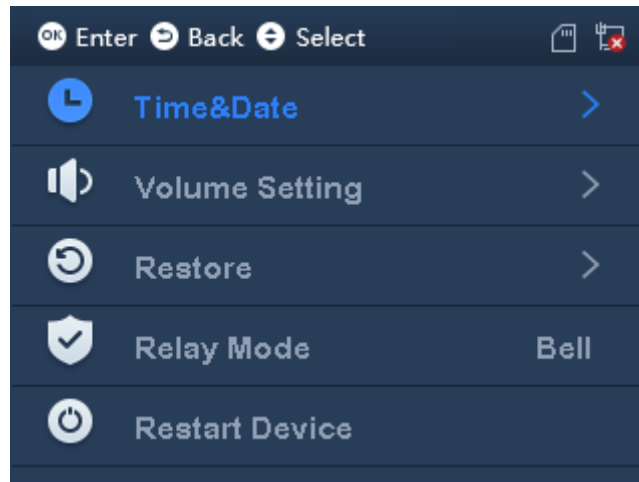

Figure 3-42

3.7.1 Set Time and Date

3.7.1.1 Set Date

Set system data and time format.

Step 1. Select SysConfig>Time&Date>Formatting Setting, click . See Figure 3-43.

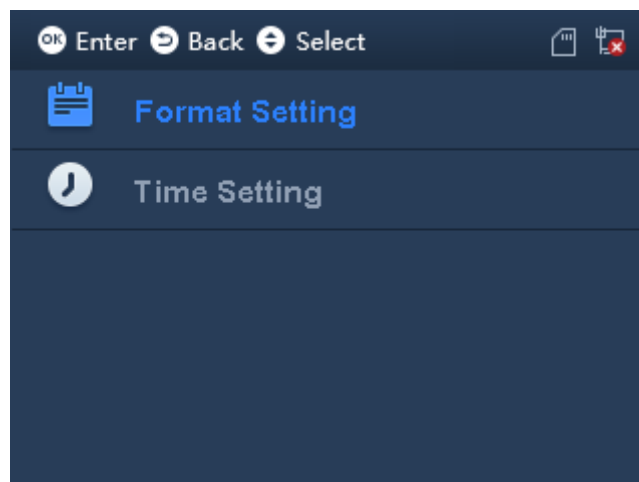





Figure 3-43

Step 2. Click  or  to select parameter, click  to switch, immediately effective.

- Date: YY-MM-DD, MM-DD-YY, DD-MM-YY.
- Time: default is 24-hour, cannot be changed.

3.7.1.2 Time Setting

Step 1. Select SysConfig>Time&Date>Time Setting, click .
See Figure 3-44.

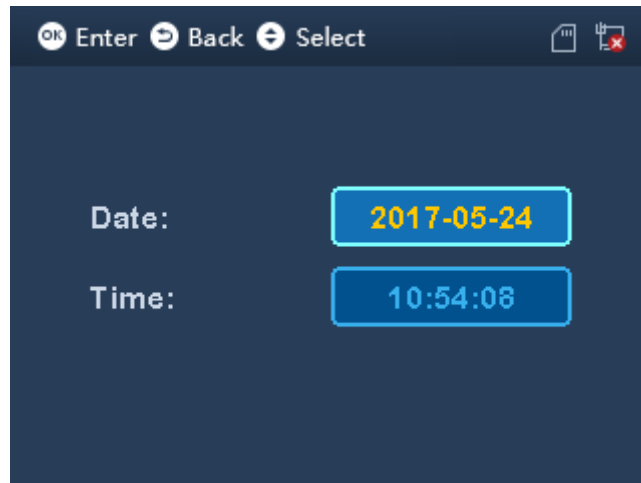



Figure 3-44

Step 2. Enter device date and time, click .

3.7.2 Volume

Step 1. Select SysConfig>Volume Setting, see Figure 3-45.

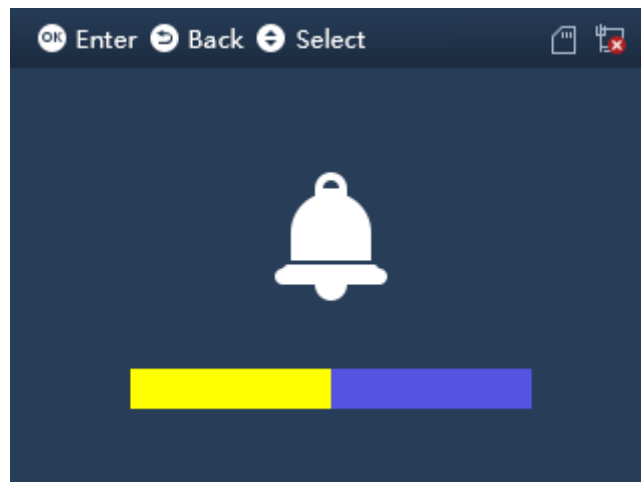



Figure 3-45

Step 2. Click  or  to adjust volume.

3.7.3 Restore

Warning:

Restore device will cause data to be lost, be cautious!

You can restore device to default, and you can decide whether to keep user info and log.

- Restore default setting have two modes: delete all settings or delete all settings but only keep user info and record. Device info and user info will be deleted.
- Restore default setting (keep user info and log), shift will be deleted.

Select SysConfig>Restore, see Figure 3-46. Click  or  to select, and click  to confirm.

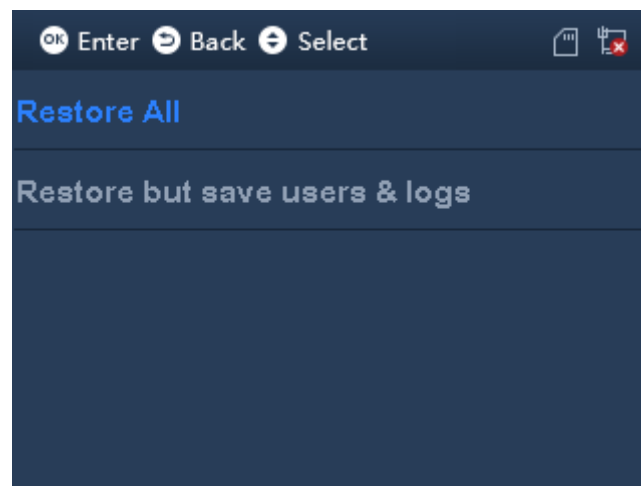

Figure 3-46

3.7.4 Relay Mode

Relay mode includes bell, lock and none modes.

- Bell, external bell device which ring according to set time.
- Unlock, when door is locked, during attendance you can control lock. Unlock hold time can be set so when the door keeps unlocked over this time length, it will be auto locked.
- None, no relay mode, no any link.

Select SysConfig>Relay Mode, see Figure 3-47.

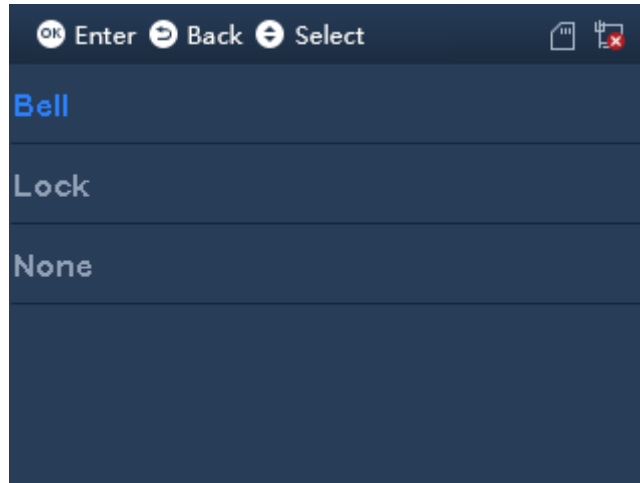



Figure 3-47



3.7.5 Restart Device

Select SysConfig>Restart Device, click  to restart.

3.8 Communication

When time attendance connects to platform, you shall set device IP address to add device on platform.

Before setup, please make sure Ethernet cable is connected, and  sign is shown on screen.

Step 1. Enter main menu, click  or  to select Comm, click . Or directly click number key 5. See Figure 3-48.

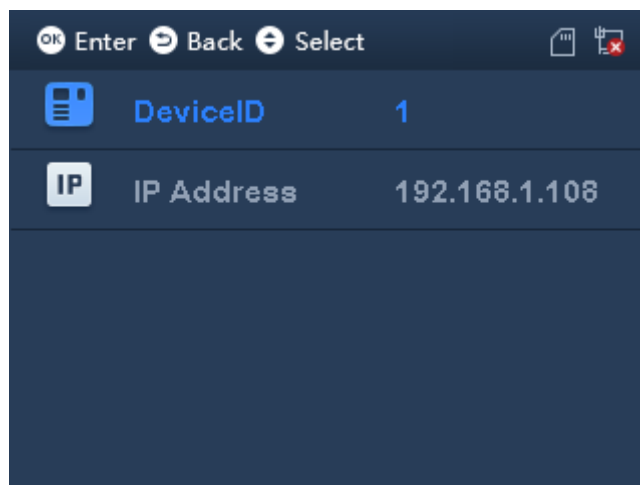



Figure 3-48

Step 2. Select IP address, click , see Figure 3-49.

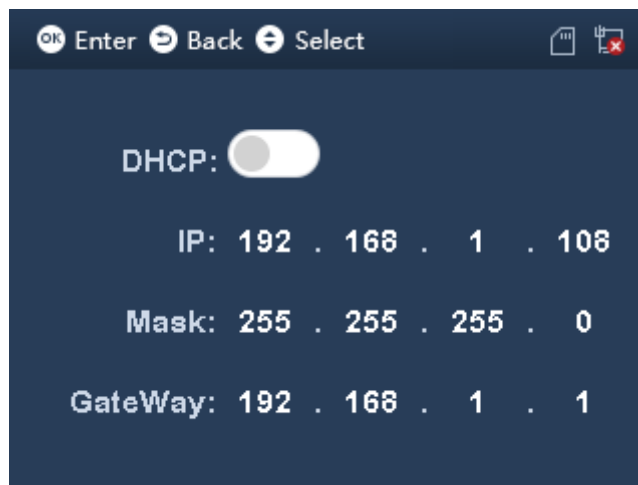



Figure 3-49

Step 3. Click  or  to select number position. Enter numberkey, see Chart 3-8.

Parameter	Note
DHCP	DHCP (Dynamic Host Configuration Protocol) Enable DHCP, auto get IP address. Now IP address, subnet mask and gateway are not available.
IP, Mask, Gateway	When DHCP is disabled, you set IP address, mask and gateway. IP address and gateway must be in the same segment.



Chart 3-8

Step 4. Click  to save.

3.9 USB

Warning:

Export user info and before updating, make sure USB is inserted. During exporting or upgrading, DO NOT eject USB disk or operate device, otherwise export or updating will fail.

Enter main menu, click  or  to select USB, click . Or directly click number key 2, see Figure 3-50.

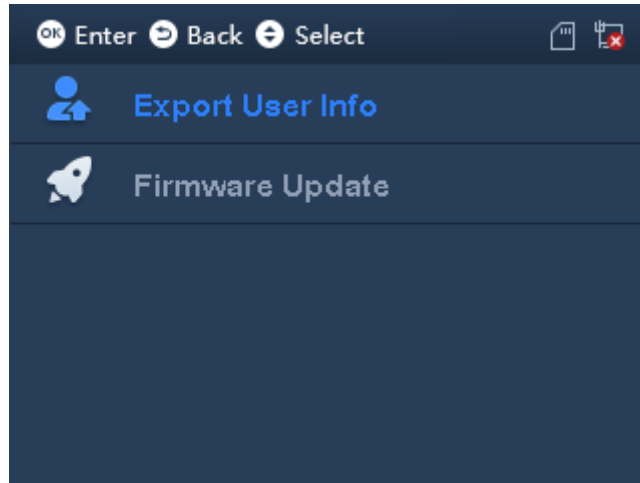

Figure 3-50

3.9.1 Export User Info

Select USB>Export User Info, click  to enter, and click  to export.

Note:

Fingerprint info cannot be exported.

3.9.2 Firmware Update



Step 1. Copy update file to USB disk, name it “update.bin”, and insert USB disk to device USB port.

Step 2. Select USB>Firmware Update, click .

Step 3. Click  again to update.

3.10 System Info

You can view user capacity, fingerprint capacity and record capacity plus current usage status.

Enter main menu, click  or  to select system info, click . Or directly click number key 8, see Figure 3-51.

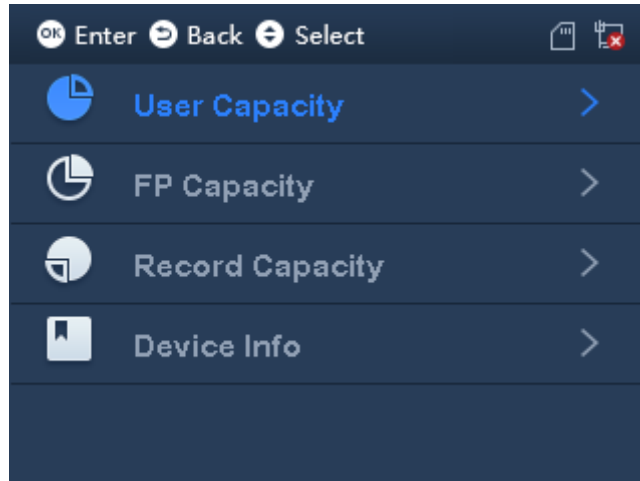

Figure 3-51

Click or to select parameter, click to enter interface.

- User capacity, FP capacity and record capacity show total capacity, used capacity and free capacity.
- Device Info, show current version MAC address and IP address.

4 Daily Operation

1. How to set unlock by device?

A: Pass admin verification, select SysConfig>Relay>Unlock set unlock time, click



Note:

The device only can set unlick time, no door sensor or alarm setup.

2. How to let device support external bell?

A: External bell is for purpose of scheduled warning.

Step 1. Pass admin verification, select SysConfig>Relay>Bell, click .

Step 2. Select Features>Bell setup, add or edit bell. Max 8 bells.

3. How to set attendance time and shift?

A:



For example to set department 1 work from 8:30 to 17:30 Monday to Friday, and off work on Saturday and Sunday.

Step 1. Select Shift>Shift setup>Shift, select attendance type and select fixed attendance.

- Set period to 8:30-17:30.
- Set cycle type. Either week or month.
- Set department shift as department bound shift.

Step 2. Select User>Department Shift, enter shift no. you set in step 1.

Note:

- Device support both fixed and flexible attendance.
 - Shift refer to Ch 3.4.1 and 3.4.2.
4. How to verify by password?
A: In standby interface, enter work ID, and click direction key to select, enter password.
Click  to complete attendance. See Ch 3.1.
5. How to view personal attendance record (general user only)?
A: After pass attendance, click  to show personal attendance record.
6. How to enter menu?
A:
- First time of operation, click  to enter menu.
 - If admin user is added, you shall pass system verification before enter main menu.
Admin user can enter by swiping card, fingerprint or entering password, see Ch 3.1.

5 FAQ

Step 1. Invalid card, cannot pass attendance.

A: Confirm if user of the card is added to attendance list.

Step 2. Bell cannot work.

A: Confirm wiring is normal, meantime make sure relay mode has selected bell.

Step 3. I cannot update device via USB.

A: Check if USB is recognized, meantime name sure update file is named "update.bin".

Appendix a Fingerprint Operation

Notice

- Keep your finger clean.
- When you record finger, place finger flat on collector, make center of finger face center of collector.

Recommended Finger

Index finger, middle finger and ring finger are recommended for fingerprint collection.

See Figure A-0-1.

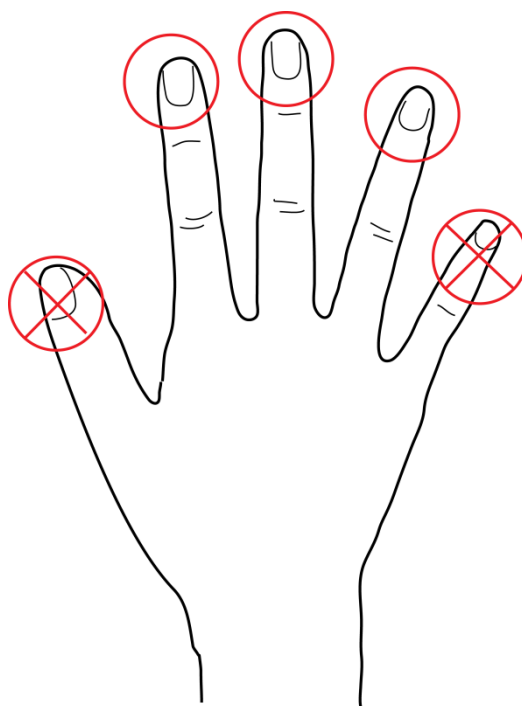

Figure A-0-1

Press

- Correct

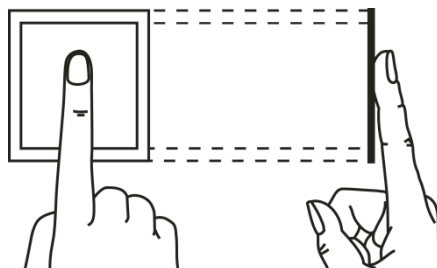

Figure A-0-2

- Incorrect

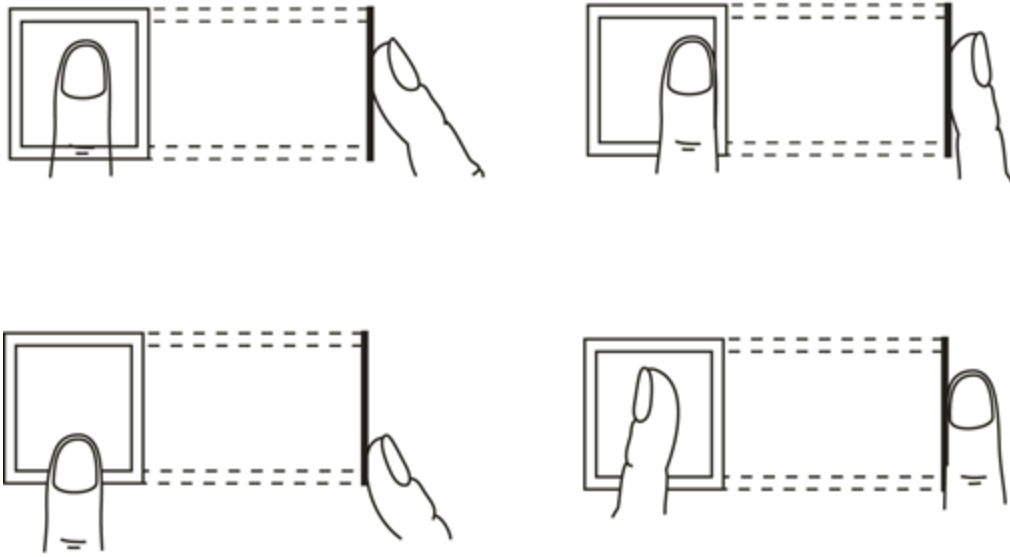

Figure A-0-3

Appendix 2 Text Input

The device support text input of English, number and symbol. Click ✖ to switch.

Number

Step 1. Click ✖ to switch input, see Figure A2-0-1.



Figure A2-0-1

Step 2. Enter number, click (OK) to confirm, see Figure A2-0-2.



Figure A2-0-2

English

Step 1. Click ✖ to switch to English, see Figure A2-0-3.



Figure A2-0-3

Step 2. Enter letter, enter corresponding letter, see Figure A2-0-4.

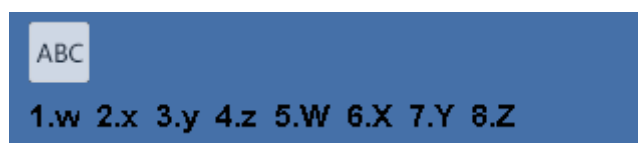

Figure A2-0-4

Step 3. Click (OK).

Symbol

Step 1. Click ✖ to switch input, see Figure A2-0-5.



Figure A2-0-5



Step 2. Click number key, enter corresponding symbol. Click  or  to flip page, see Figure A2-6.



Figure A2-6

Step 3. Click  to confirm.

Note:

- **This manual is for reference only. Slight difference may be found in user interface.**
- **All the designs and software here are subject to change without prior written notice.**
- **All trademarks and registered trademarks are the properties of their respective owners.**
- **If there is any uncertainty or controversy, please refer to the final explanation of us.**
- **Please visit our website or contact a user local service engineer for more information.**